

- E** Instrucciones de montaje
- C** Instruccions de muntatge
- GB** Assembly instructions
- F** Instruction de montage
- D** Montageanleitung
- PT** Instruções de montagem
- I** Istruzioni di montaggio
- PL** Instrukcja montażu
- CZ** Montážní návod
- HU** Szerelési Utasítás
- RO** Instrucțiuni de montaj
- HR** Detaljne upute
- TU** Öncelikle montaj

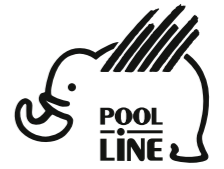

POOL-LINE ACCESORIOS, S.L.
 C. Esqueis, 19. P. I. Can Barri
 08415- Bigues i Riells. Barcelona (España)
 www.pool-line.net

Nº HOMOLOGACIÓN: **E9** 26R-03.1042







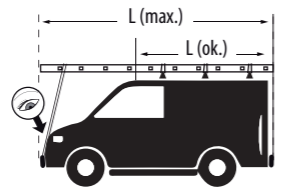





RECYCLABLE

123915

Rv: 6/2020



- NISSAN NV400 L3 H2 (2010->)
- OPEL MOVANO B L3 H2 (2010->)
- RENAULT MASTER III L3 H2 (2010->)

N		Q
21	 S-1550	1
22	 L-1300	6
23	 B-1022	6
24	 T-1535	10
25		20
26		2
27		2
28		10
30	 CHA-M8	20
31	 ISO 7380 M8x40	20
32	 ISO 7380 M8x16	28
33	 DIN 125 Ø 8	62

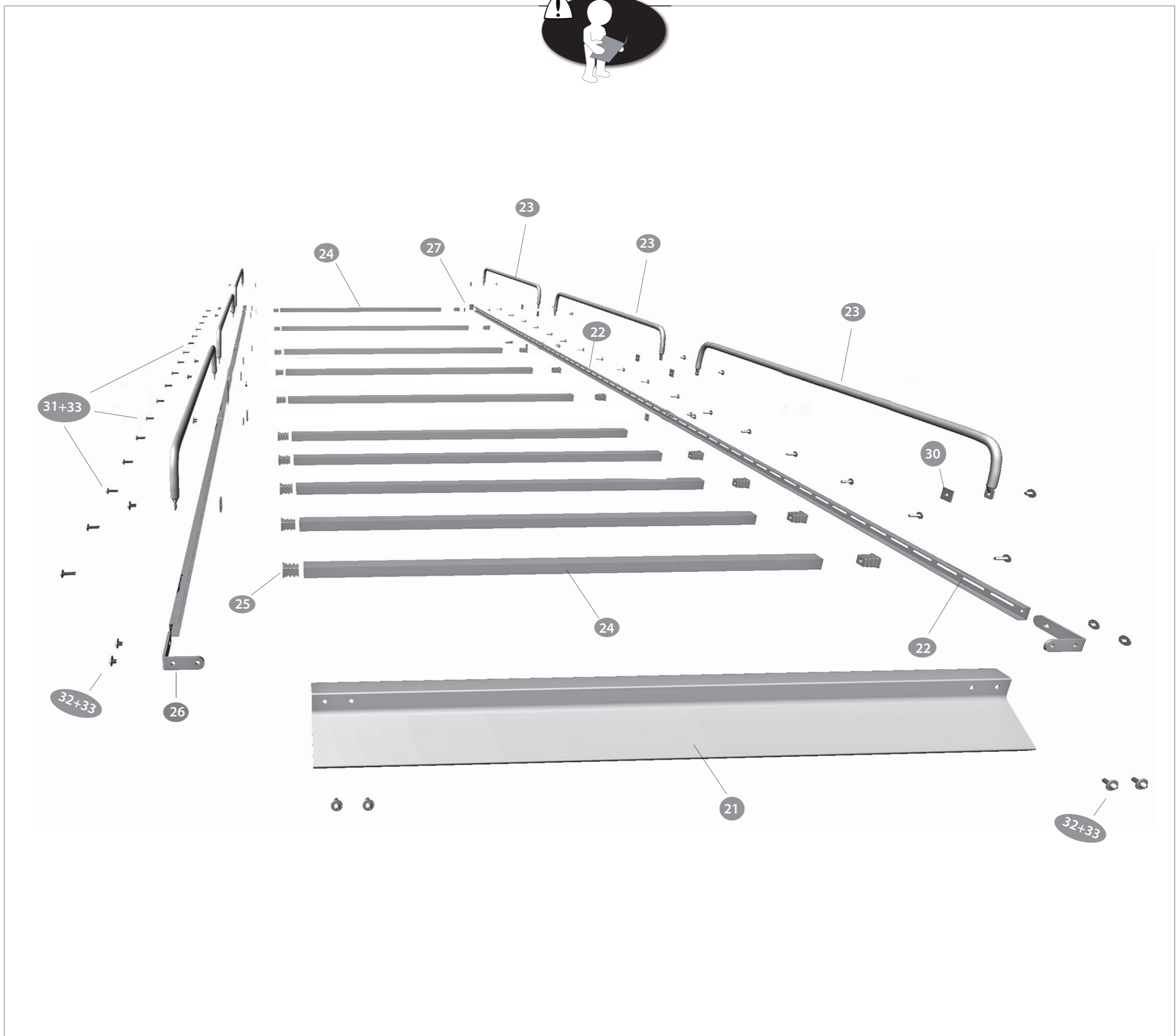

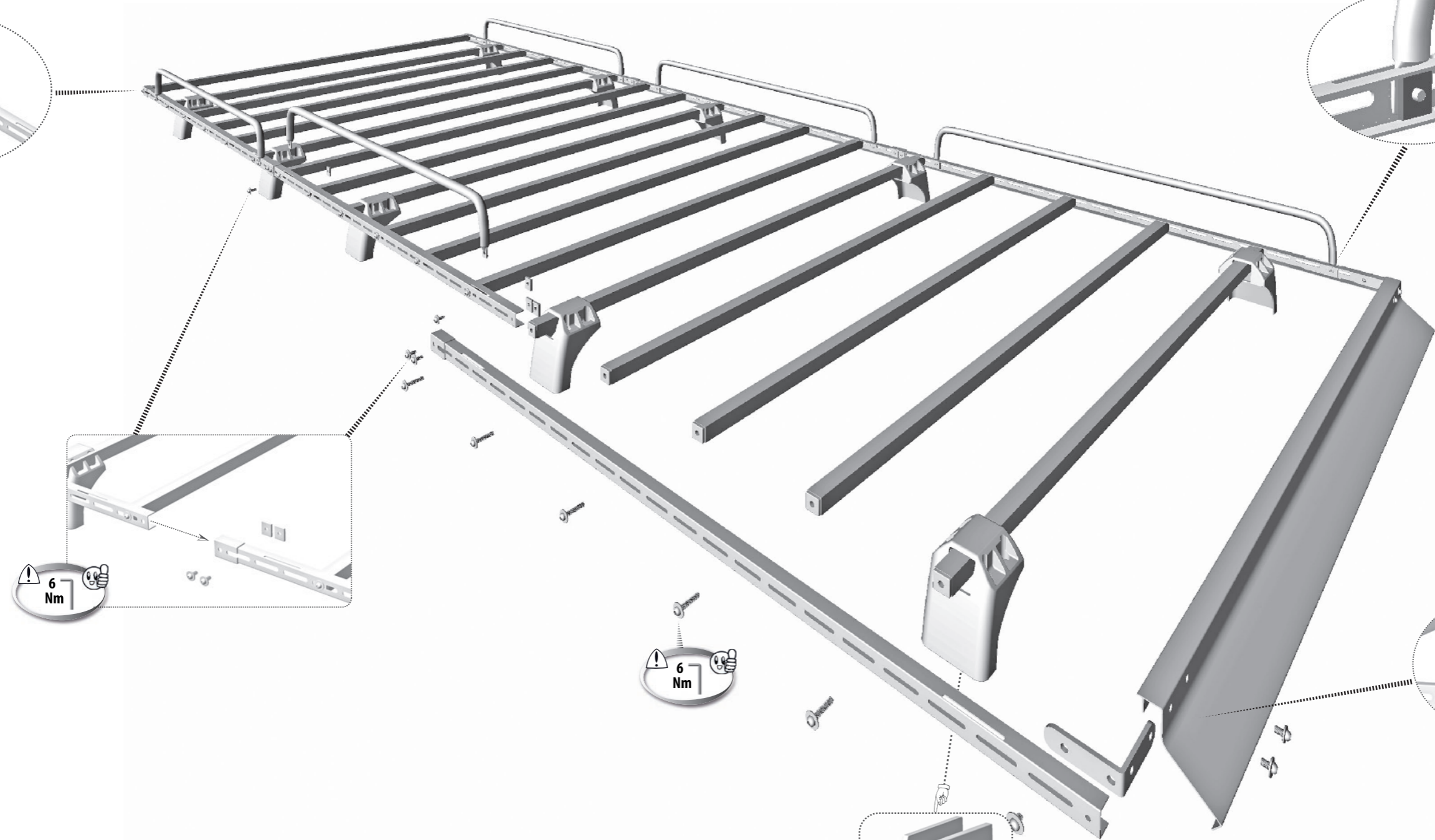
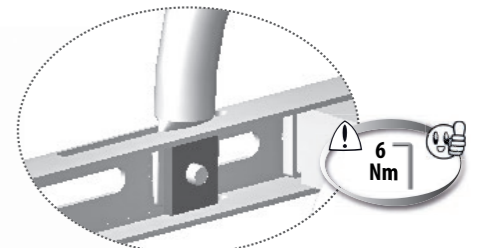
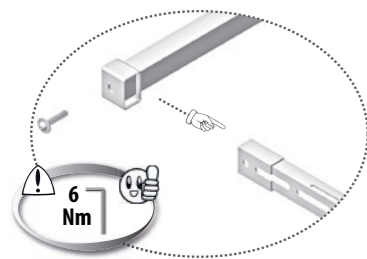
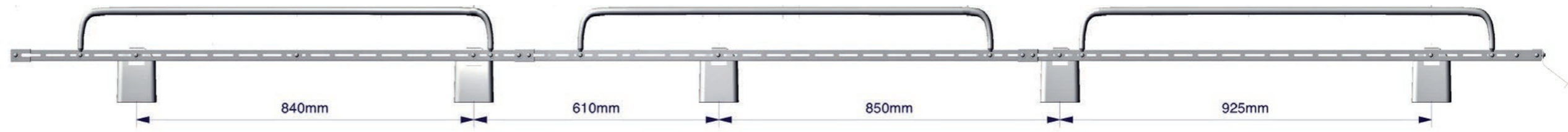

Zona delantera
 Zone avant
 Front zone
 Zone anteriore
 Vorderzone

