

- E** Instrucciones de montaje
- C** Instruccions de muntatge
- GB** Assembly instructions
- F** Instruction de montage
- D** Montageanleitung
- PT** Instruções de montagem
- I** Istruzioni di montaggio
- PL** Instrukcja montażu
- CZ** Montážní návod
- HU** Szerelési Utasítás
- RO** Instrucțiuni de montaj
- HR** Detaljne upute
- TU** Öncelikle montaj

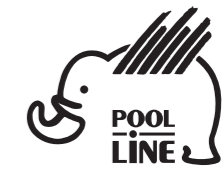

POOL-LINE ACCESORIOS, S.L.  
 C. Esqueis, 19. P. I. Can Barri  
 08415- Bigues i Riells. Barcelona (España)  
 www.pool-line.net

**50** **KG.**  
**MAX.**

Nº HOMOLOGACIÓN: **E9** 26R04/00\*1085\*01

**RECICLABLE**

**EVO-FIX II**  
**111013**

Review 12/2022

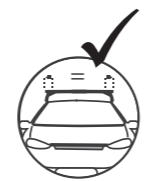
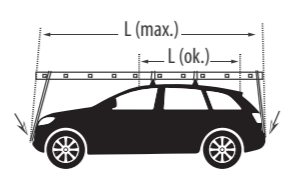
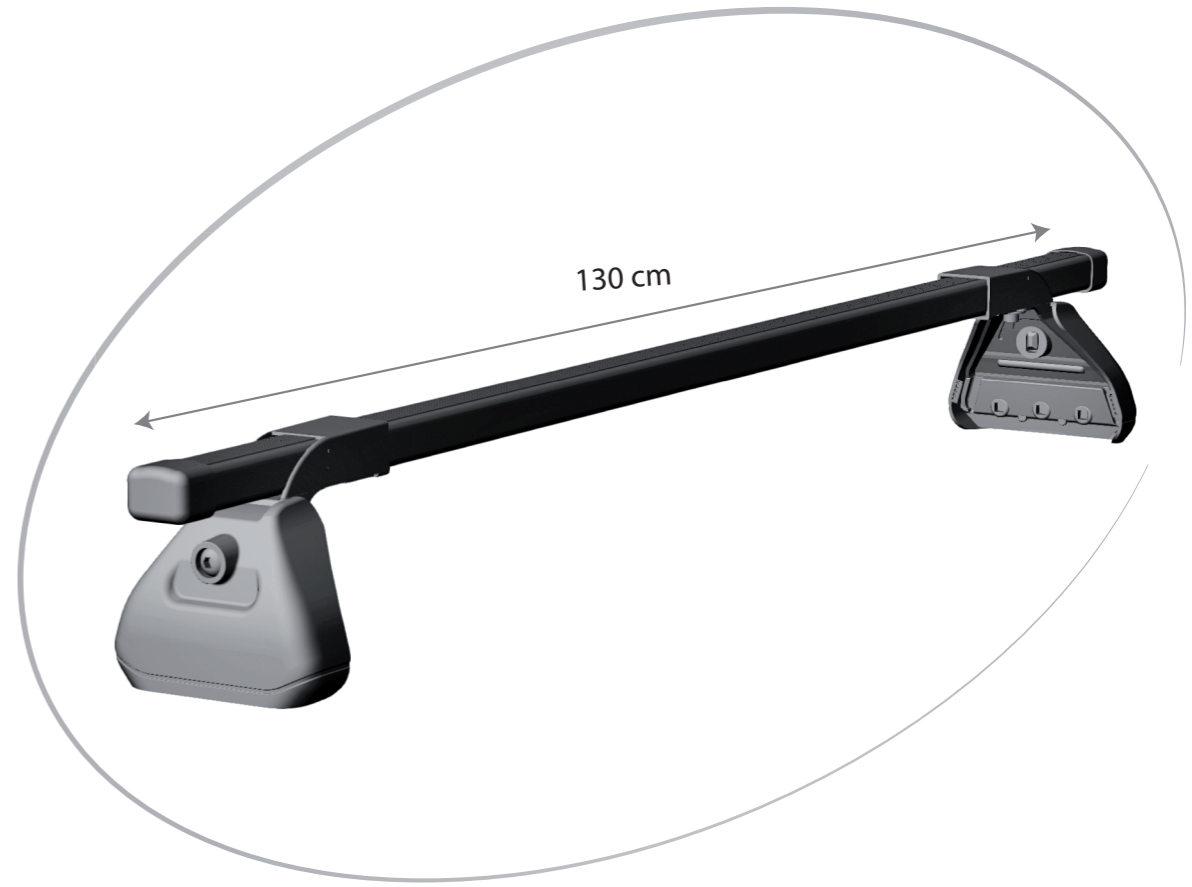

*Nota: Guardar instrucciones para posibles montajes y desmontajes.*



1

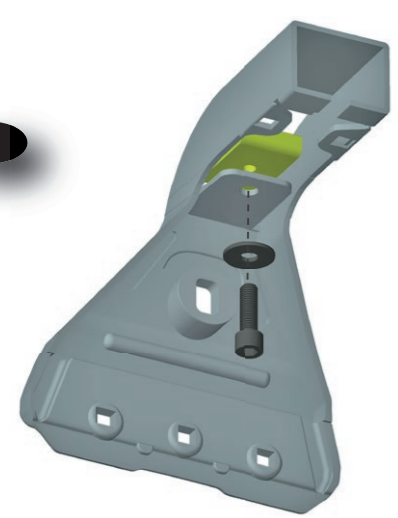

2



3

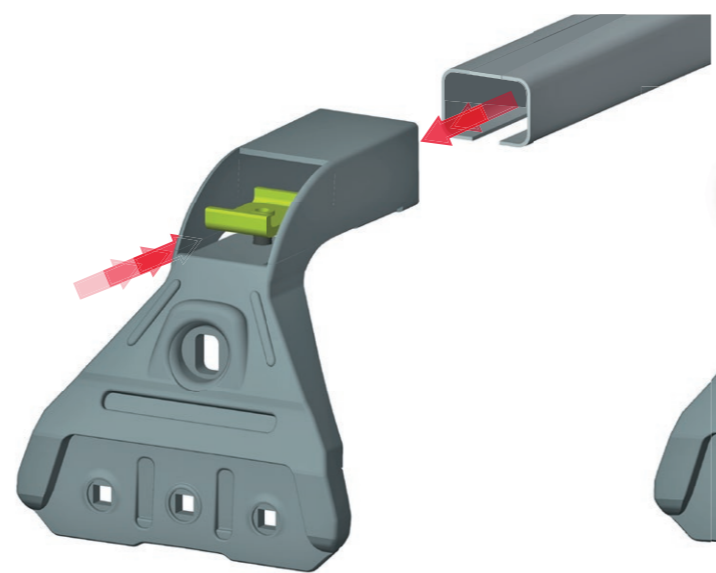

4

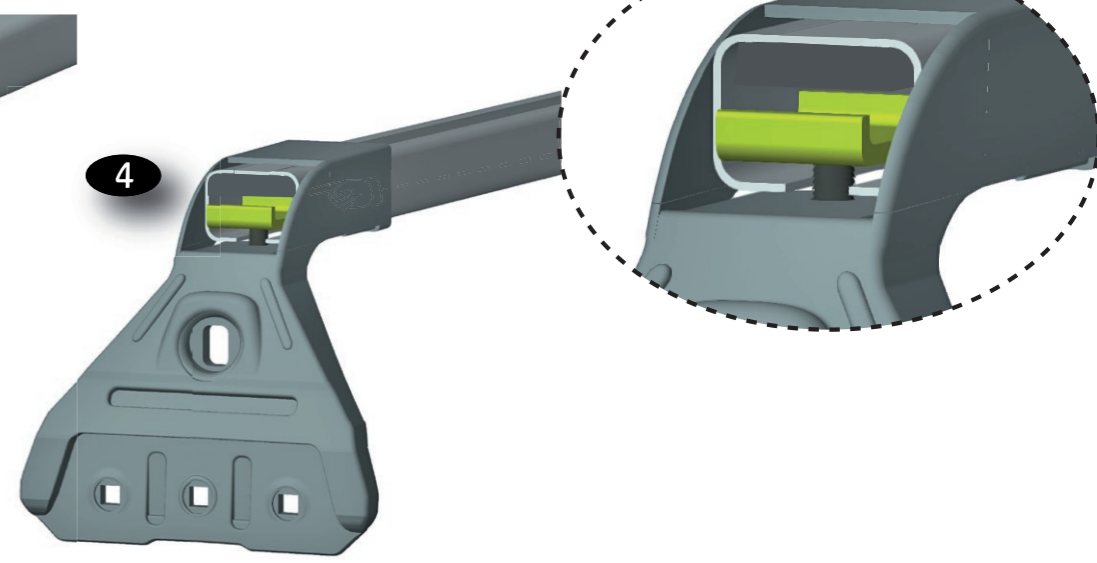

5

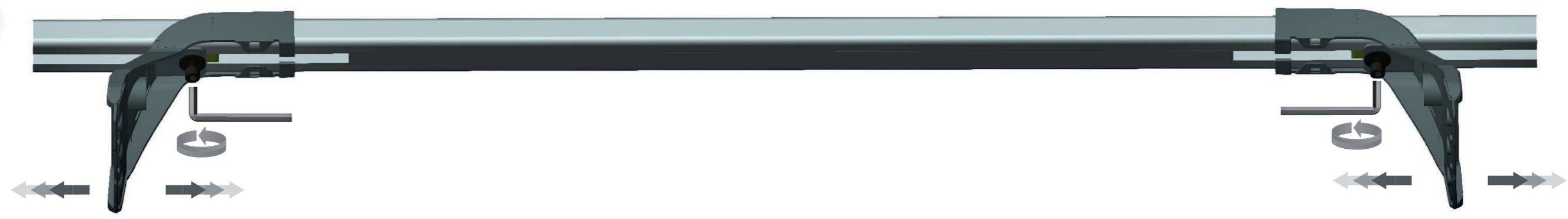

6

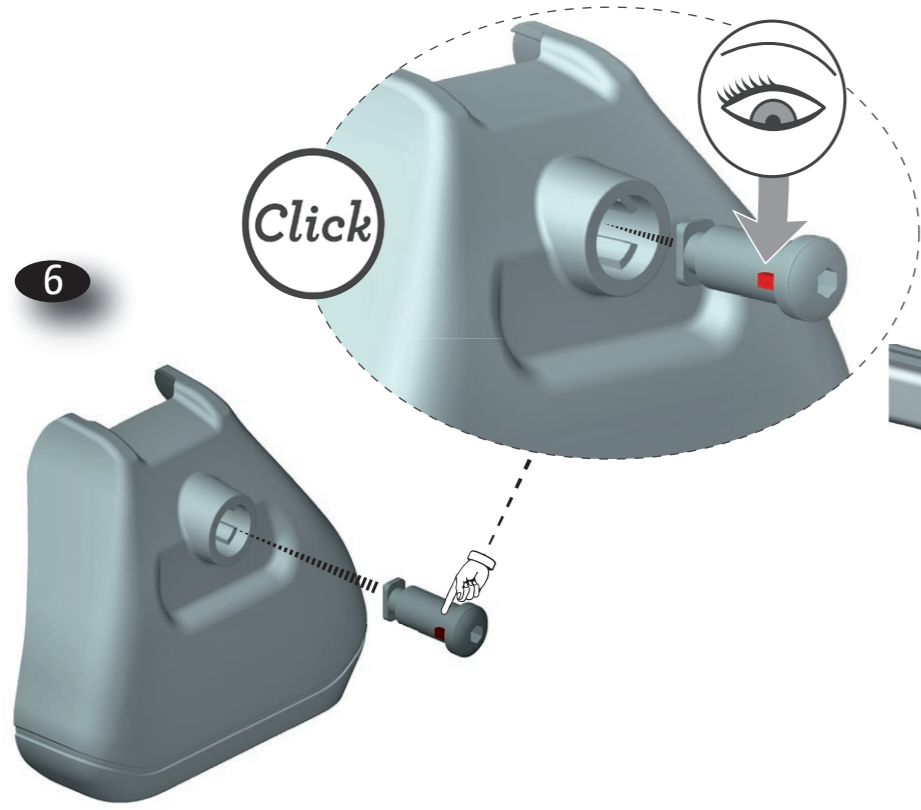

7

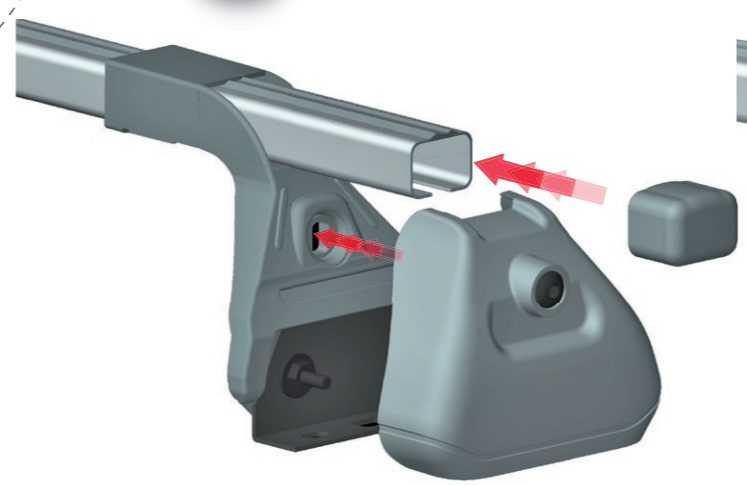

8



9

